

WORX®

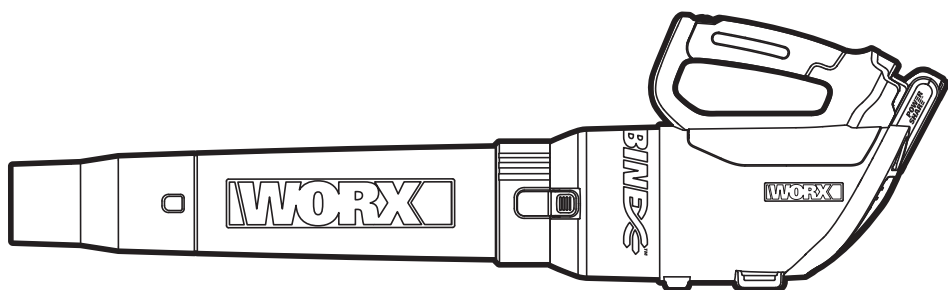

SAFETY AND OPERATING MANUAL

**Cordless Li-Ion Blower/Sweeper
WG546E WG546E.1 WG546E.2 WG546E.9**



 **WARNING: Read all safety warnings and all instructions.** Failure to follow the warnings and instructions may result in electric shock, fire and/or serious injury.

Save all warnings and instructions for future reference.

The appliance is only to be used with the power supply unit provided with the appliance.

**IMPORTANT
READ CAREFULLY BEFORE
USE.**

**KEEP FOR FUTURE
REFERENCE**

SAFE OPERATING PRACTICES

1) TRAINING

- a) Read the instructions carefully. Be familiar with the controls and the correct use of the machine.
- b) Never allow children, persons with reduced physical, sensory or mental capabilities or lack of experience and knowledge or people unfamiliar with these instructions to use the machine, local regulations may restrict the age of the operator.
- c) Never operate the machine while people, especially children, or pets are nearby.
- d) Keep in mind, that the operator or user is responsible for accidents or hazards occurring to other people or their property.

2) PREPARATION

- a) While operating the machine, always wear substantial footwear and long trousers. Do not operate the machine when barefoot or wearing open sandals. Avoid wearing clothing that is loose fitting or that has hanging cords or ties.
- b) Do not wear loose clothing or jewellery that can be drawn into the air inlet. Keep long hair away from the air inlets.
- c) Obtain ear protection and safety glasses. Wear them at all times while operating the machine.
- d) Operate the machine in a recommended position and only on a firm, level surface.
- e) Do not operate the machine on a paved or gravel surface where ejected material could cause injury.
- f) Before using, always visually inspect to see, that the fasteners are secure, the housing is undamaged and that guards and screens are in place. Replace worn or damaged components in sets to preserve balance. Replace damaged or unreadable labels.

3) OPERATION

- a) Before starting the machine, make certain that the feeding chamber is empty.
- b) Keep your face and body away from the feed intake opening.
- c) Do not allow hands or any other part of the body or

- clothing inside the feeding chamber, discharge chute, or near any moving part.
- d) Keep proper balance and footing at all times. Do not overreach. Never stand at a higher level than the base of the machine when feeding material into it.
 - e) Always stand clear of the discharge zone when operating this machine.
 - f) if the machine should start making any unusual noise or vibration, immediately shut off the power source and allow the machine to stop. Remove the battery pack from the machine and take the following steps before restarting and operating the machine:
 - i) inspect for damage;
 - ii) replace or repair any damaged parts;
 - iii) check for and tighten any loose parts.
 - g) Do not allow processed material to build up in the discharge zone; this may prevent proper discharge and can result in kickback of material through the intake opening.
 - h) If the machine becomes clogged, shut-off the power source and remove the battery pack from the machine before cleaning debris.
 - i) Never operate the machine with defective guards or shields, or without safety devices.
 - j) Keep the power source clean of debris and other accumulations to prevent damage to the power source or possible fire.
 - k) Do not transport this machine while the power source is running.
 - l) Always disconnect the machine from the power supply (e.g. remove the battery pack from the machine)
 - whenever you leave the machine,
 - before clearing blockages or unclogging chute,
 - before checking, cleaning or working on the machine.
 - m) Avoid using the machine in bad weather conditions especially when there is a risk of lightning.

4) MAINTENANCE AND STORAGE

- a) keep all nuts, bolts and screws tight to be sure the appliance is in safe working condition.
- b) Replace worn or damaged parts.
- c) Use only genuine replacement parts and accessories.
- d) Store the machine in a dry place out of the reach of children.
- e) When the machine is stopped for servicing, inspection, or storage, or to change an accessory, shut off the power source, disconnect the machine from the supply and make sure

that all moving parts are come to a complete stop. Allow the machine to cool before making any inspections, adjustments, etc. Maintain the machine with care and keep it clean.

- f) Store the machine in a dry place out of the reach of children.
- g) Always allow the machine to cool before storing.
- h) Never attempt to override the interlocked feature of the guard.

SAFETY WARNINGS FOR BATTERY PACK

- a) Do not dismantle, open or shred cells or battery pack.**
- b) Do not short-circuit a battery pack. Do not store battery packs haphazardly in a box or drawer where they may short-circuit each other or be short-circuited by conductive materials.**

When battery pack is not in use, keep it away from other metal objects, like paper clips, coins, keys, nails, screws or other small metal objects, that can make a connection from one terminal to another. Shorting the battery terminals together may cause burns or a fire.

- c) Do not expose battery pack to heat or fire. Avoid storage in direct sunlight.**
- d) Do not subject battery pack to mechanical shock.**









- e) In the event of battery leaking, do not allow the liquid to come into contact with the skin or eyes. If contact has been made, wash the affected area with copious amounts of water and seek medical advice.**
- f) Seek medical advice immediately if a cell or battery pack has been swallowed.**
- g) Keep battery pack clean and dry.**
- h) Wipe the battery pack terminals with a clean dry cloth if they become dirty.**
- i) Battery pack needs to be charged before use. Always refer to this instruction and use the correct charging procedure.**
- j) Do not maintain battery pack on charge when not in use.**
- k) After extended periods of storage, it may be necessary to charge and discharge the battery pack several times to obtain maximum performance.**
- l) Battery pack gives its best performance when it is operated at normal room temperature (20°C ± 5°C).**
- m) When disposing of battery packs, keep battery packs of different electrochemical systems separate from each other.**
- n) Recharge only with the charger specified by WORX.**

Do not use any charger other than that specifically provided for use with the equipment. A charger that is suitable for one type of battery pack may create a risk of fire when used with another battery pack.

- o) Do not use any battery pack which is not designed for use with the equipment.**
- p) Keep battery pack out of the reach of children.**
- q) Retain the original product literature for future reference.**
- r) Remove the battery from the equipment when not in use.**
- s) Dispose of properly.**

SYMBOLS

	Read the operator's manual
	Wear eye protection
	Wear ear protection
	Keep bystanders away

	Warning of hazard
	Do not use in the rain or leave outdoors while it is raining.
	Make sure the battery is removed prior to changing accessories.
 Li-Ion	Li-Ion battery. This product has been marked with a symbol relating to 'separate collection' for all battery packs and battery pack. It will then be recycled or dismantled in order to reduce the impact on the environment. Battery packs can be hazardous for the environment and for human health since they contain hazardous substances.
 Li-Ion	
	x1NR18/65-y: Cylindrical lithium Ion battery cells with max diameter of 18mm and max height of 65mm; "x" represents a number cells serial connected, blank if 1; "-y" represents a number of cells paralleled connected, blank if 1.
	Do not burn
	Do not expose to rain or water
 N5112	RCM MARKING
	ABN: Australian Business Number. By this number, business information such as entity type, status, business location etc. can be found at website http://abr.business.gov.au . ABN of Positec Australia Pty Limited is 14 101 682 357

**Cordless Li-Ion Blower/Sweeper
WG546E WG546E.1 WG546E.2 WG546E.9**

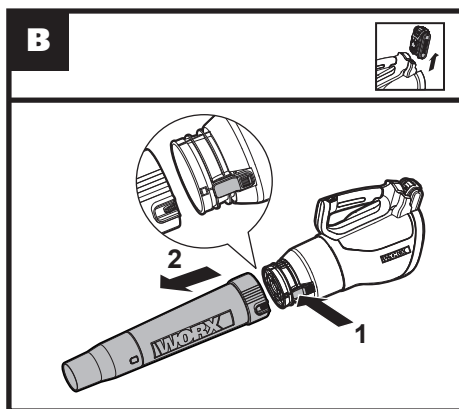
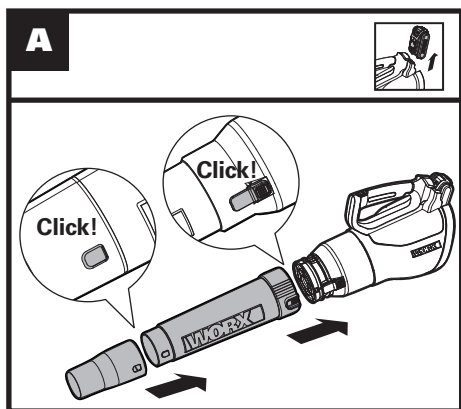
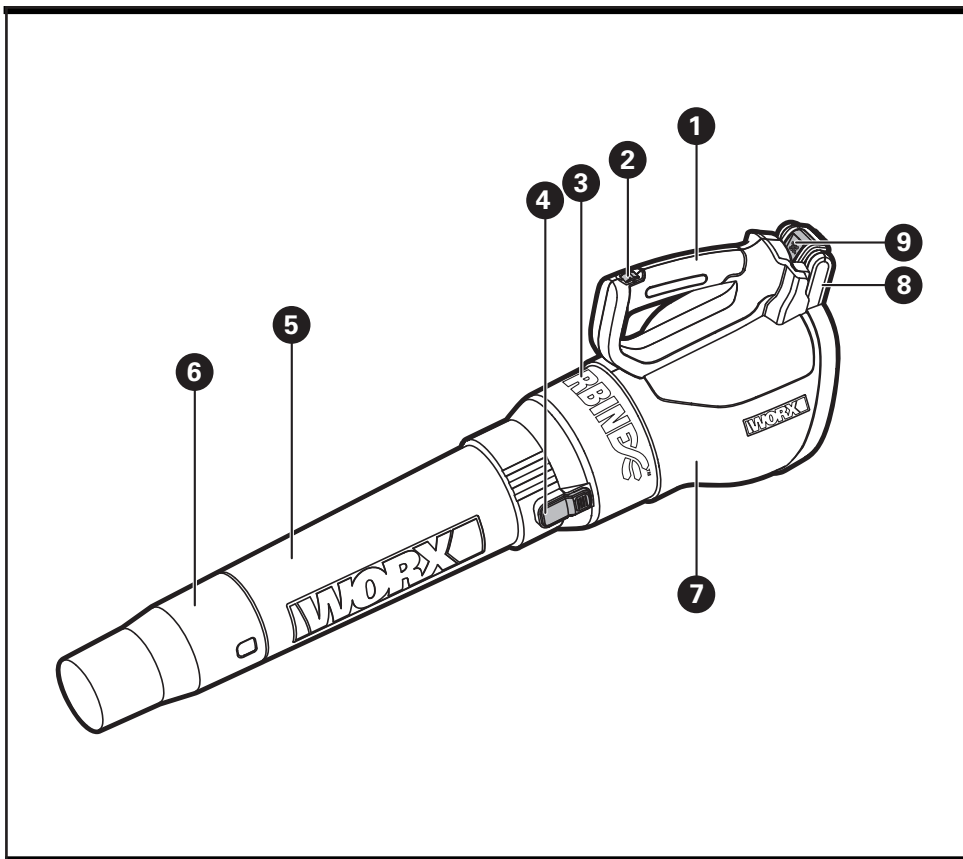

**Cordless Li-Ion Blower/Sweeper
WG546E WG546E.1 WG546E.2 WG546E.9**

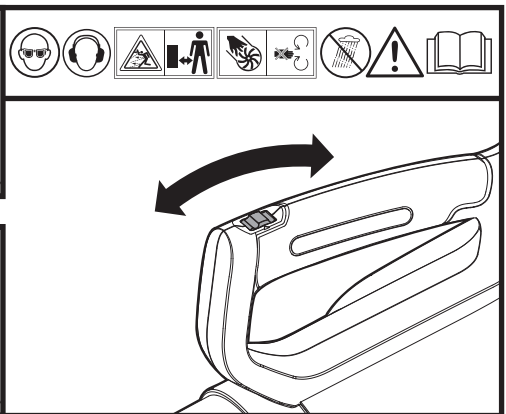
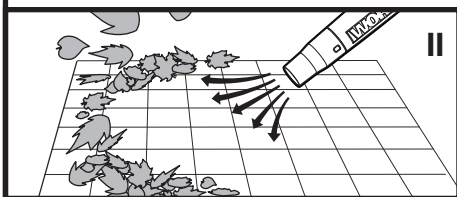
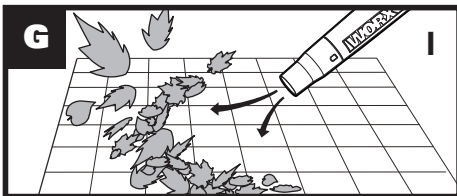
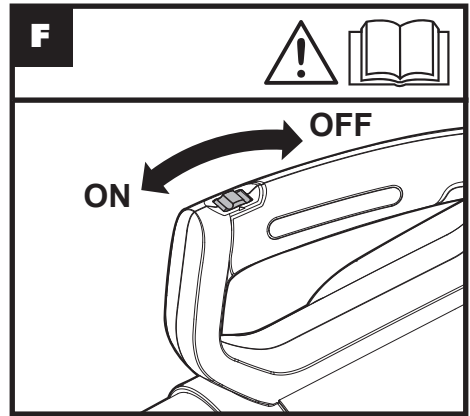
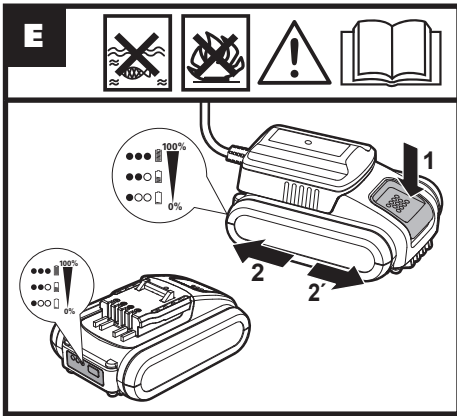
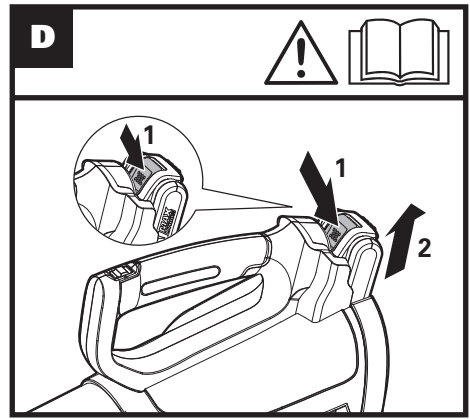
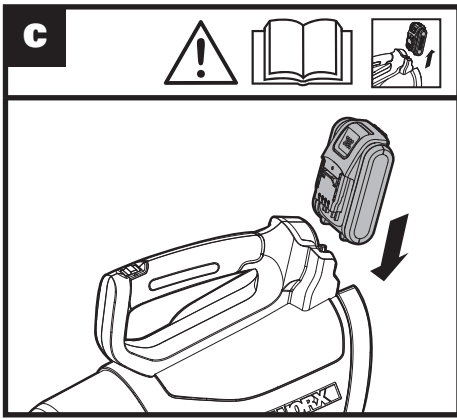

**Cordless Li-Ion Blower/Sweeper
WG546E WG546E.1 WG546E.2 WG546E.9**

1. HANDLE
2. ON/OFF SWITCH
3. FAN HOUSING
4. TUBE RELEASE BUTTON
5. UPPER BLOWER TUBE
6. LOWER BLOWER TUBE
7. MOTOR HOUSING
8. BATTERY PACK*
9. BATTERY PACK RELEASE BUTTON*

*Not all the accessories illustrated or described are included in standard delivery.

TECHNICAL DATA

Type **WG546E WG546E.1 WG546E.2 WG546E.9 (520-559-designation of machinery, representative of Cordless Blower)**

	WG546E WG546E.2	WG546E.1	WG546E.9
Rated voltage	20V \approx Max**		
Air speed	I: 97km/h II: 145km/h		
Air volume	I: 6.4m ³ /min II: 9.6m ³ /min		
Charging time	5hr (approx.)	2hr (approx.)	/
Machine weight	2.6 kg	2.9 kg	1.9kg

** Voltage measured without workload. Initial battery voltage reaches maximum of 20 volts. Nominal voltage is 18 volts.

NOISE DATA

A weighted sound pressure	L_{pA} : 83dB (A) K_{pA} : 3.0dB(A)
A weighted sound power	L_{wA} : 99dB(A)
Wear ear protection	

VIBRATION INFORMATION

Typical weighted vibration	$a_h < 2.5m/s^2$
Uncertainty	$K = 1.5m/s^2$

The declared vibration total value may be used for comparing one tool with another, and may also be used in a preliminary assessment of exposure.

WARNING: The vibration emission value during actual use of the power tool can differ from the declared value depending on the ways in which the tool is used dependant on the following examples and other variations on how the tool is used:

How the tool is used and the materials being cut or drilled.

The tool being in good condition and well maintained Using the correct accessory for the tool and ensuring it is sharp and in good condition.

The tightness of the grip on the handles and if any anti vibration accessories are used.

And the tool is being used as intended by its design and these instructions.

This tool may cause hand-arm vibration syndrome if its use is not adequately managed

WARNING: To be accurate, an estimation of exposure level in the actual conditions of use should also take account of all parts of the operating cycle such as the times when the tool is switched off and when it is running idle but not actually doing the job. This may significantly reduce the exposure level over the total working period.

Helping to minimise your vibration exposure risk. ALWAYS use sharp chisels, drills and blades Maintain this tool in accordance with these instructions and keep well lubricated (where appropriate)

If the tool is to be used regularly then invest in anti vibration accessories.

Avoid using tools in temperatures of 10°C or less Plan your work schedule to spread any high vibration tool use across a number of days.

Cordless Li-Ion Blower/Sweeper WG546E WG546E.1 WG546E.2 WG546E.9

ACCESSORIES

	WG546E	WG546E.1
Battery pack	1(WA3760)	1(WA3860)
Charger	1(WA3551)	1(WA3553)

	WG546E.2	WG546E.9
Battery pack	1(WA3760)	/
Charger	2(WA3551)	/

We recommend that you purchase your accessories from the same store that sold you the tool. Choose the type according to the work you intend to undertake. Refer to the accessory packaging for further details. Store personnel can assist you and offer advice.



OPERATION

INTENDED USE:

The blower is intended for residential use only. Use the blower outdoors to move yard debris as needed.

ASSEMBLY AND OPERATION

ACTION	FIGURE
Assembling & disassembling the Blower Tube	See Fig. A&B
10 Installing & Removing the Battery Pack NOTE: Depress the battery release button to release battery pack from your tool. After recharging, insert the battery pack into tool's battery port. A simple push and slight pressure will be sufficient.	See Fig. C&D
Checking the battery condition BEFORE USING YOUR CORDLESS BLOWER Your battery pack is UNCHARGED, you must charge before use. Charging the battery More details can be found in WA3760's manual  WARNING! The charger and battery pack are specially designed to work together, so do not attempt to use any other devices. Never insert or allow metallic objects into your charger or battery pack connections because of an electrical failure and hazard will occur.	See Fig. E

Starting & Stopping  WARNING! The tool runs for a few seconds after it has been switched off. Let the motor come to a complete standstill before setting the tool down.	See Fig. F
Blowing USERTIPS - Hold the blow tube approximately 8" above the ground when operating the tool. Use a sweeping motion from side to side. Advance slowly keeping the accumulated debris/leaves in front of you. - After blowing the debris/leaves into a pile, it is easy to dispose of the pile.  CAUTION! - Do not blow hard objects such as nails, bolts, or rocks. - Do not operate the blower near bystanders or pets. - Use extra care when cleaning debris from stairs or other tight areas. - Wear safety goggles or other suitable eye protection, long pants, and shoes.	See Fig. G
Adjusting the Blowing Speed	See Fig. G

CLEANING THE TOOL

Clean the tool regularly.

- 
- WARNING! Keep your product dry. Under no circumstances spray with water.**
- To clean the tool, use only mild soap and a damp cloth.
 - Do not use any type of detergent, cleaner or solvent which may contain chemicals that could seriously damage the plastic.
 - Self lubricating bearings are used in your product, therefore lubrication is not required.

Cordless Li-Ion Blower/Sweeper

WG546E WG546E.1 WG546E.2 WG546E.9

Positec Australia Pty Limited
10 Corporate Blvd Bayswater, VIC 3153, Australia

Cordless Li-Ion Blower/Sweeper
WG546E WG546E.1 WG546E.2 WG546E.9

WORX
it's your nature

www.worx.com

Copyright © 2018, Positec. All Rights Reserved.
AP02154202